

MAF350C

Auto Hand Sanitizer Dispenser

Model No. : MAF350C

Specifications

H x W x D	214 x 116 x 85 mm 8.42 x 4.56 x 3.34 inch
Material	ABS
Power Supply	Three (3) C-cell Alkaline Batteries
Battery Life	25,000 Hand washes or 1.5 year stand-by
Volume	0.4ml per dispense
Capacity	500ml Disposable/Interchangeable cartridge
Installation	Wall Mount (Screws / Adhesive)

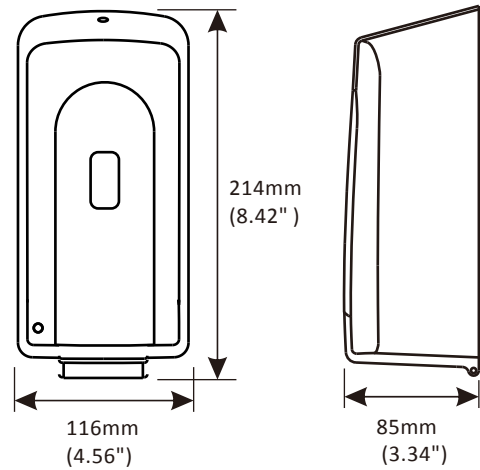

PARTS

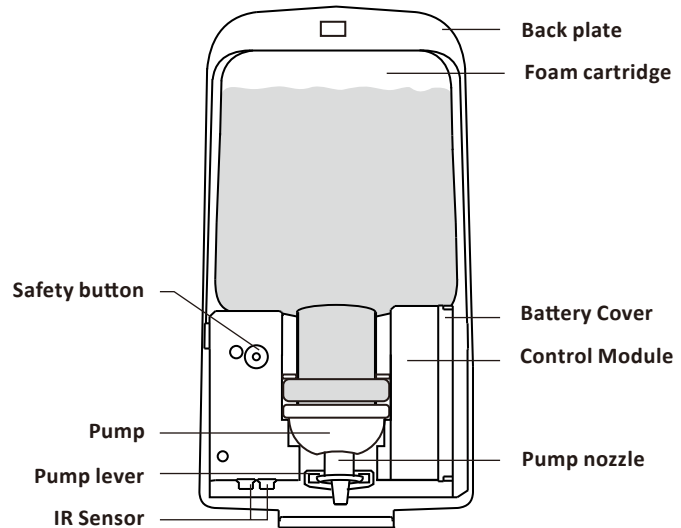
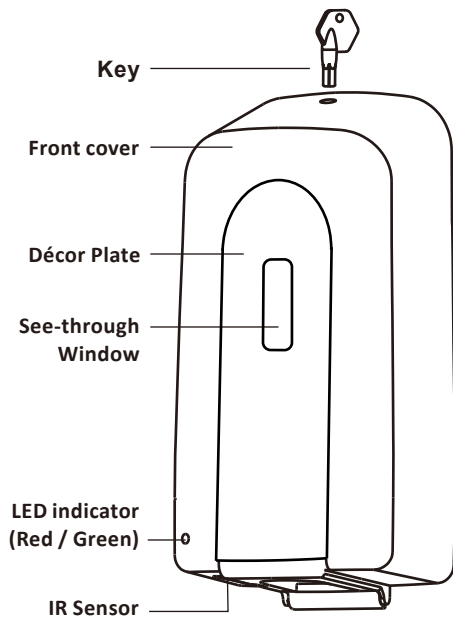

TROUBLESHOOTING / before calling for repair of Control Module

PROBLEM: liquid is not dispensed

1. Check if foam soap has run out
2. Check if Pump Nozzle is clogged

PROBLEM: dispenser does not operate

1. Check if pump nozzle is in securely position
2. **RED LED lights up**
dispenser is not closed properly: Check if cover of dispenser securely closed
3. **RED LED blinks**
batteries are low: Check if the batteries need to be replaced
4. **GREEN LED lights up**
sensor is been detected: Check and remove if an object is in the sensing range

INSTALLATION

Locating Dispenser

Mounted at least 30cm (12") above the surface. Allow 10cm (4") clearance above dispenser to be able to use key to open cover.

Do not install above a mirrored surface or mount under flowing water.

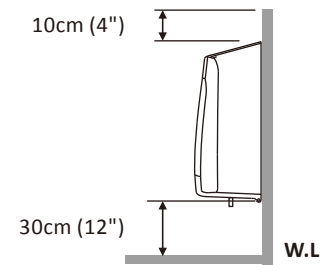

Adhesive tape mounting (Fig.1)

Tape mounting is only recommended for mirrors or similar surface. Make sure the mounting surface is flat. Clean surface well and dry. Remove protective backing off from adhesive tape and press dispenser firmly to the wall for 15 seconds. Open cover and press directly on back plate for an additional 15 seconds. Allow 6 hours before using dispenser and installing refill and batteries.

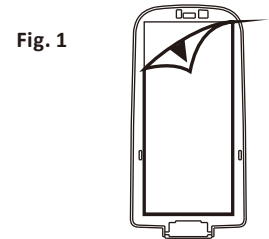

Fig. 1

Screws and anchors mounting (Fig. 2)

Drill holes at a proper position on the wall. Install provided anchors and use screw to secure the dispenser permanently on the wall.

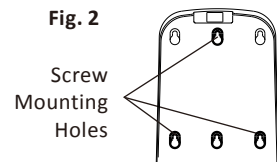

Fig. 2

Battery Installation (Fig.3)

Use provided key to open dispenser.

Insert three C-cell Alkaline batteries (not included) into battery compartment on the right side of the unit after removing battery cover.

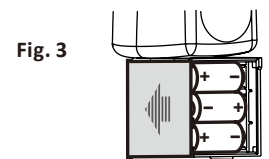

Fig. 3

3 X C-cell battery

Cartridge Installation (Fig.4)

Place the cartridge on top of the control module with the pump facing from and orientated downward. Pump nozzle should be easy to fit into the groove of Pump Lever on the control module.

Close dispenser cover. **GREEN** LED blink **3** times. The dispenser is now ready to be used, **GREEN** LED indicator comes to flash once every 5 seconds.

Place hands beneath the Sensor on the left hand side of the dispenser allow 1-2 seconds, **GREEN** LED lights and will dispense foaming soap onto your hand.

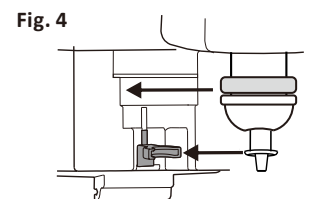

Fig. 4

Pump Lever

OPERATING INSTRUCTIONS

- Power **ON** after front cover was closed.
GREEN LED blinks 3 times to indicate unit is ready to be used.
GREEN LED will then keep flashing once every 5 seconds.
- Power **OFF** when front cover was opened.
RED LED indicator will light up.
- **Low-Battery** the RED LED will blink to indicate the batteries are low, need replacement.